

Sharkoon

X-REST 7.1

SURROUND SOUND HEADSET STAND



Manual

TABLE OF CONTENTS

1. Features	3
2. Specifications	3
2.1 General	3
2.2 Cable and Connectors	3
2.3 Software Properties	4
2.4 Compatibility	4
3. Package Contents	4
4. X-Rest 7.1 Overview	4
5. Connecting to Devices	5
5.1 PC and Mac	5
5.2 PlayStation 4	5
5.3 Headset with Two Stereo Jacks	5
5.4 Headset with One Stereo Jack	5
6. Functions	6
6.1 Microphone Mute	6
6.2 Equalizer Button	6
6.3 Volume Control	7
7. Installing the Software	8
8. Software	8
9. FAQ	11

Dear Customer,

Thank you for your purchase of this Sharkoon product. To ensure a long service life and full functionality, we recommend that you read this manual thoroughly.

We hope you enjoy your time using our product!

SHARKOON Technologies
www.sharkoon.com

1. Features:

- Illuminated headset stand with integrated 7.1 USB sound card for realistic surround sound
- Compatible with all headsets and headphones with 3.5 mm stereo jacks
- Easily accessible controls for the equalizer, microphone mute and volume control
- Ideal complement for the PC sound card and suitable as a second sound source for use of speakers and headsets
- Angular gaming style design; organizes headsets on every type of gamer desktop
- Weighted base with anti-sliding rubber feet for better stability and a more secure stand
- Textile braided cable
- 7.1 audio software with profiles, effect settings and microphone boost
- Stereo mode via USB possible without driver installation

2. Specifications:

2.1 General

Type	Headset Stand with USB Sound Card
Sound Chip	SSS1629A5
Surround Mode	Virtual 7.1*
Connector	USB
Volume Control	✓
Microphone Mute	✓
Hardware Equalizer	✓
Illumination	✓
Power Supply	USB
Weight without Cable	380 g
Dimensions (L x W x H)	120 x 120 x 260 mm
Supported Operating Systems	Windows 7/8/10, MacOS X**

2.2 Cable and Connectors

Interfaces	2x 3.5 mm Stereo Jacks
Textile Braided Cable	✓
Cable Length	200 cm

2.3 Software Properties

Profile	4
Equalizer	✓
Effect Settings	Off, Theater, Bathroom, Living Room, Corridor
3D Sound	✓
Virtual 7.1 Sound	✓
Microphone Boost	✓

2.4 Compatibility

PCs/Notebooks	✓
PlayStation 4	✓**

* Only with installed software through Windows

** Mac OS X/PlayStation 4: Only stereo

3. Package Contents

- X-Rest 7.1
- Manual
- CD with software and manual

Note:

Should any of the above items be missing, please contact our customer service immediately:

support@sharkoon.com
(Germany and Europe)

support@sharkoon.com.tw
(International)

4. X-Rest 7.1 Overview

- A** Headset stand with base
- B** Microphone mute
- C** Microphone port
- D** Headset port, also TRRS port
- E** Equalizer Button
- F** Volume control



5. Connecting to Devices

5.1 PC and Mac

Insert the USB plug of the X-Rest 7.1 into an available USB port on your PC. The base LED light will illuminate blue. Your operating system will automatically recognize the X-Rest 7.1 and install all needed drivers.

Note:

If the X-Rest 7.1 is not recognized, disconnect it and try a different USB port on your PC.

Stereo headset use is now possible. For virtual 7.1 sound, as well as other numerous features, install the included software; see section "8. Software" (only Windows PC).

5.2 PlayStation 4

Insert the USB plug of the X-Rest 7.1 into an available USB port on the PlayStation 4. The X-Rest 7.1 will be automatically recognized, and the headset and microphone will be activated. To adjust the microphone level, go to the "Settings" menu – Equipment – Audio Equipment.

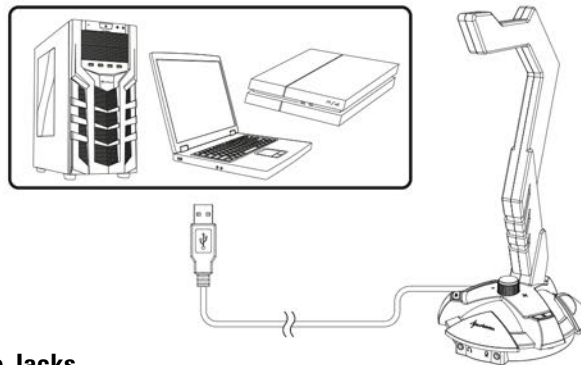

5.3 Headset with Two Stereo Jacks

Insert the headset stereo jacks into the designated ports on the X-Rest 7.1. Plug the headset jack into the port with the headset symbol. Plug the microphone jack into the microphone port.

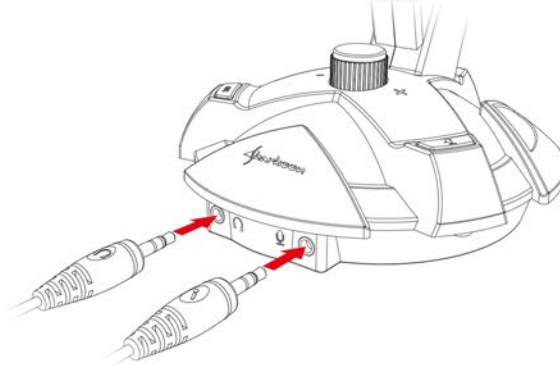

5.4 Headset with One Stereo Jack

If the headset has only a single TRRS plug (CTIA configuration), insert it into the headset port.

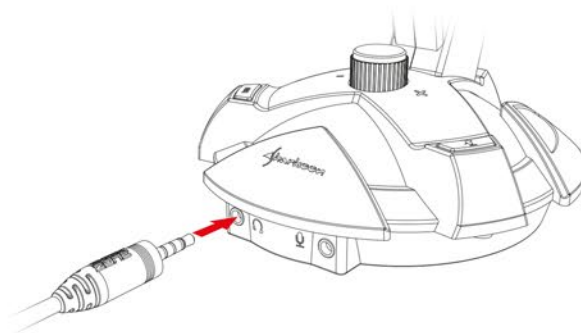

6. Functions

6.1 Microphone Mute

The microphone mute button (B) mutes your microphone, after which the X-Rest 7.1 base illumination will switch from blue to red. Press the button again to reactivate the microphone, whereupon the illumination will change back to blue (only during activated LED illumination).

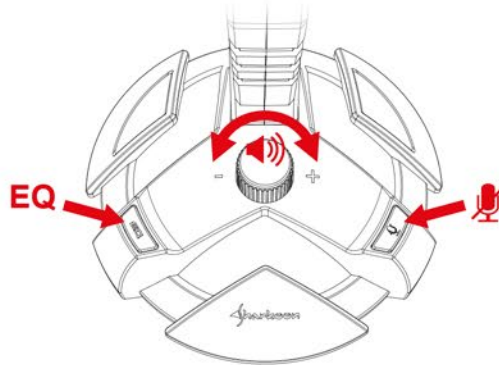

6.2 Equalizer Button

The X-Rest 7.1 comes with eight pre-programmed equalizer presets. By repeatedly pressing the equalizer button, these presets cycle through in succession.

Note:

The most recently used preset is saved and selected once the computer is restarted. If desiring a different preset, simply press the EQ button. When pressing the EQ button after the eighth preset, the preset list will simply go back to the first preset and then cycle through all presents again.

Example: If the fourth preset is active and you want to switch to the seventh preset, press the EQ button three times. Again, if the fourth preset is active and you want to switch to the first preset, press the EQ button five times.

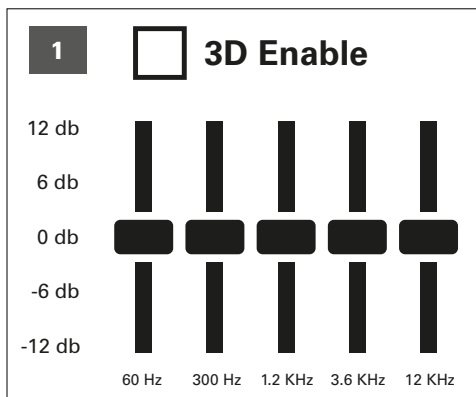

Neutral tone, no 3D effect

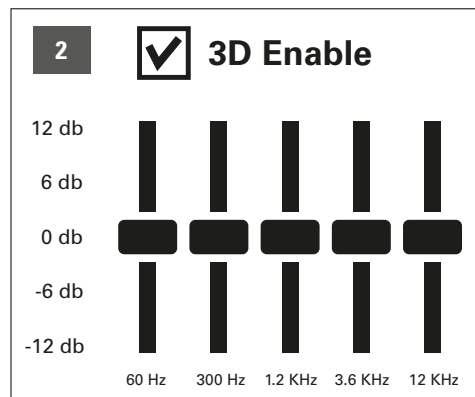

Neutral tone, with 3D effect

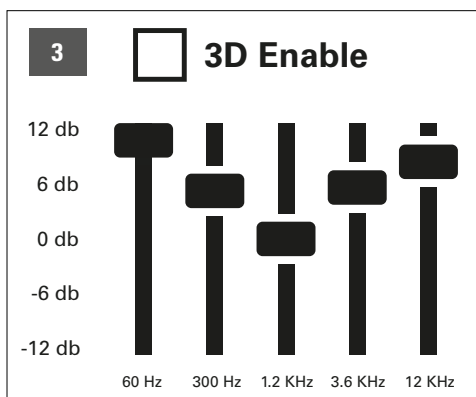

Accentuated highs and lows (Loudness), no 3D effect

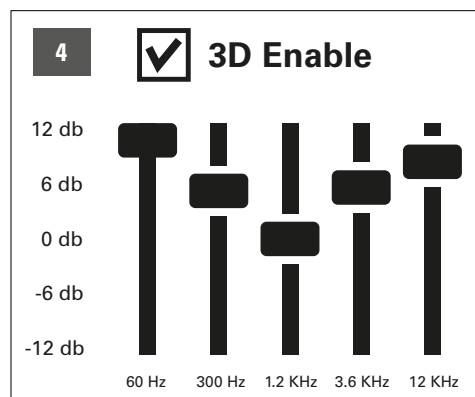

Accentuated highs and lows (Loudness), with 3D effect

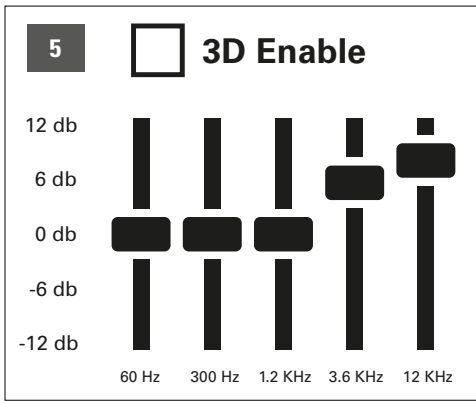

Accentuated highs and neutral lows, no 3D effect

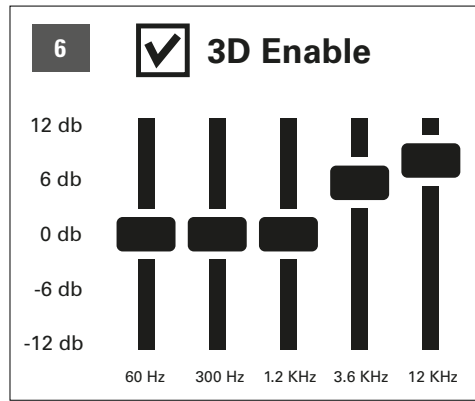

Accentuated highs, neutral lows and 3D effect

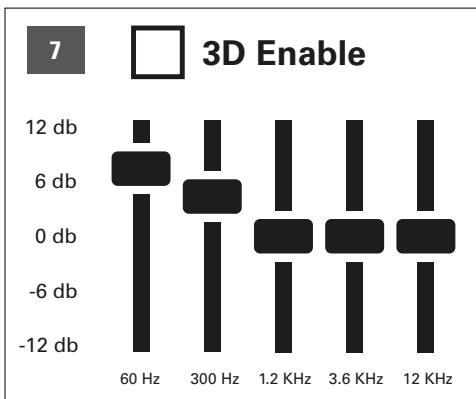

Accentuated lows and neutral highs, no 3D effect

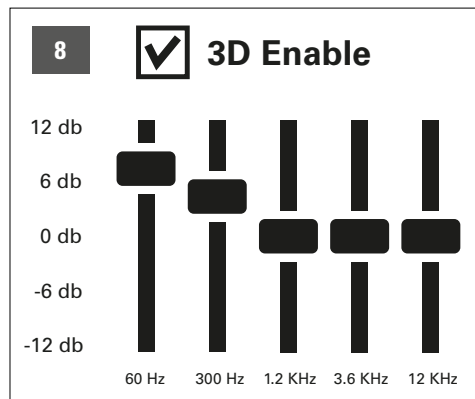

Accentuated lows, neutral highs and 3D effect

This function is also available without the installed software. If using the Windows software, four individual equalizer profiles are available instead.

6.3 Volume Control

Use the volume control knob to adjust the volume of the connected headset. To decrease the volume, turn the knob to the left. To increase the volume, turn the knob to the right.

Note:

If the volume is too low, check the overall volume on your operating system and set it to the maximum volume.

7. Installing the Software (only Windows PC)

1. Insert the CD into your CD/DVD/BD drive.
2. The software will open automatically for installation. Select "Software Installation" on the menu.



If the window does not automatically open, please proceed as follows:

- 2.1 Open the drive for the CD/DVD/BD drive (i.e. D:\).
- 2.2 Open the folder "Software".
- 2.3 Start the application "X-Rest 7.1 Setup.exe".

3. Follow the instructions on the installation wizard.
4. Once complete, click "Finish".

Alternatively, the latest software version is available for download directly from our website at www.sharkoon.com.

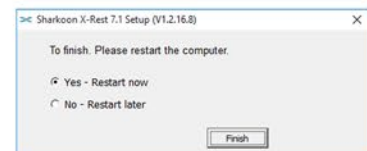
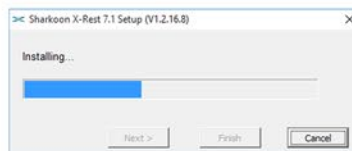

8. Software

The software allows:

- Creating, saving and loading four individual equalizer sets
- Use of four preset effects
- Microphone boost settings
- Virtual 7.1 sound configuration
- Turning on/off the LED illumination

Note:

Right-click on the X-Rest taskbar icon to change the language under the "Language" option. Likewise, select "Skins" to change the frame around the menu to either light or dark. The changes take effect immediately. A restart or reinstallation of the software is not necessary.

Open the software by double-clicking on the X-Rest 7.1 icon on the taskbar.

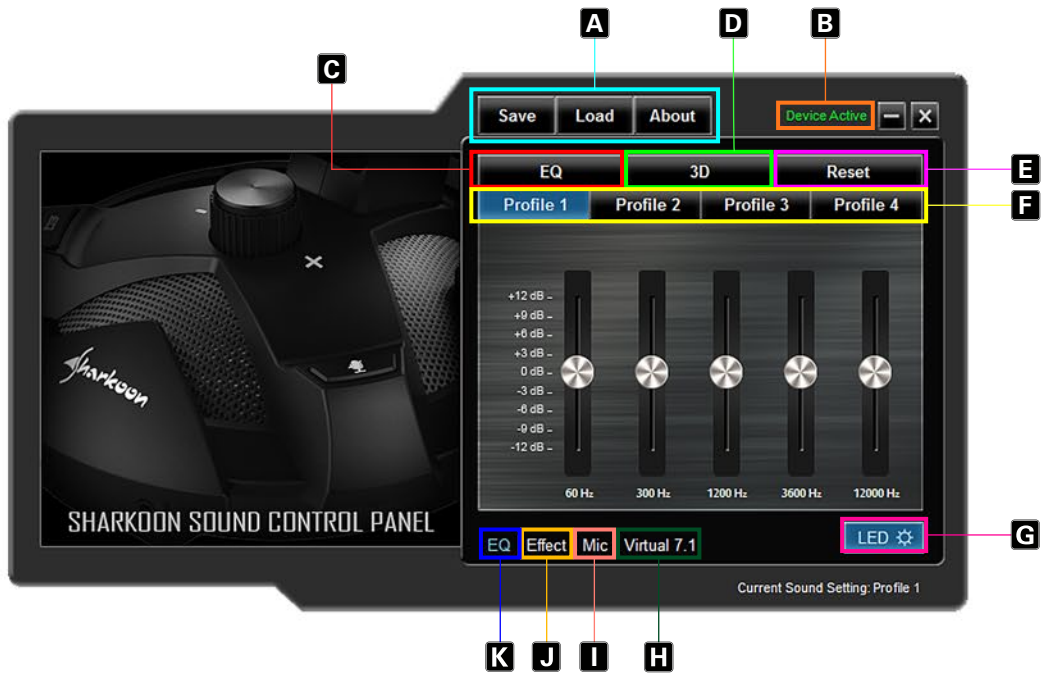

- A** Save, Load, About
- B** Device Active/Deactivated
- C** EQ (on/off)
- D** 3D (on/off)
- E** Reset
- F** Profile 1 - 4
- G** LED
- H** Virtual 7.1
- I** Microphone
- J** Effect
- K** EQ

A Save, Load, About

“Save” allows the current file configuration to be stored on the hard drive. “Open” allows a file to be loaded. All four profiles are saved as well as the selected effects, microphone setting and the 7.1 setting.

To save a configuration file, proceed as follows:

- Click on “Save”. A new window will appear
- Select the desired location and enter a file name
- Click “Save”. The file has now been created

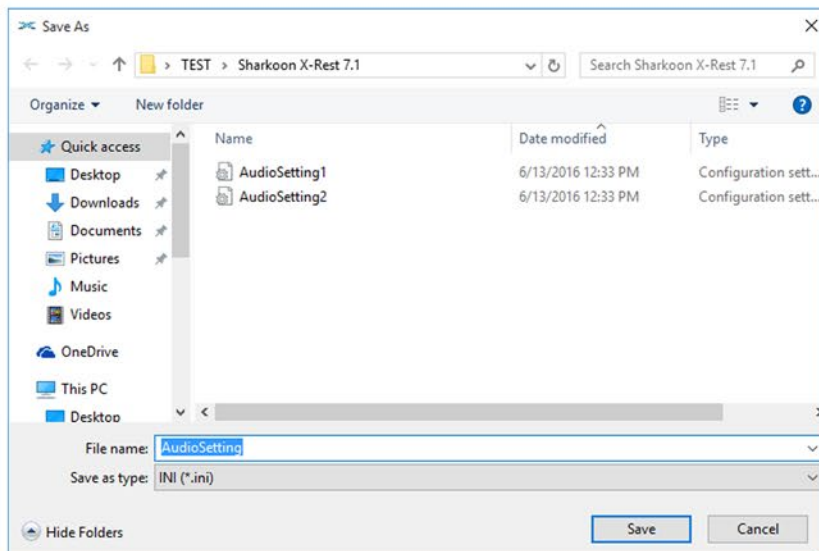

To load a configuration file, proceed as follows:

- Click on “Load”. A new window will appear
- Select the desired file and then click “Open”
- The configuration has now been loaded

Through these steps, multiple configurations can be saved and loaded. The box “About” displays the program version.

B Device Active/Deactivated

At this point, the X-Rest 7.1 status is displayed. If “Device Deactivated” appears in red text, the X-Rest 7.1 is not detected. In this situation, please check the USB connection. “Device Active” in green text means that the device is found and now ready for use.

C EQ (on/off)

Click here to turn the equalizer on/off. When the equalizer is active, the field is highlighted blue.

D 3D (on/off)

Click here to turn the 3D effect on/off. When 3D is active, the field is highlighted blue.

E Reset

Click here to reset the equalizer within the currently selected profile back to the default setting.

F Profiles 1 - 4

Select the desired profile here. Changes always affect the currently selected profile.

Adjust the sound by using the 5-band equalizer. To do this, using your mouse, move the slider either up or down. The following frequencies are available: 60, 300, 1200, 3600 and 12000 Hz.



G LED

Click here to turn on/off the X-Rest 7.1 LED illumination. The LED illuminated is active when the button is highlighted blue.

H Virtual 7.1

Under “Virtual 7.1” each of the eight virtual speakers can be individually repositioned. To do so, click on the desired speaker and then drag it into position.

To test the room effect, rotate the selected configuration either clockwise or counterclockwise. To do this, click on the corresponding arrow above the graph. Music or sound effects played are adjusted based on where the speakers were placed. Click “Reset” to restore back to default configuration.



I Microphone

Within the “Mic” menu, adjust the microphone sensitivity by increments up to 100. The “Boost” function amplifies the signal. Click “Mute” to mute the microphone.



J Effect

Adjust the sound for the four preset effects here.

Possible settings are:

- No Effect
- Theater
- Bathroom
- Living Room
- Corridor



K EQ

Clicking on this field to launch the “Equalizer” menu.

9. FAQ

The software CD has been lost

The latest version of the software and manual is available for download on our website at www.sharkoon.com.

I adjusted the equalizer, how do I turn it off?

Through the EQ button:

The most recently used preset is saved and will be selected once the computer is restarted. If you want to call up a different preset, simply press the EQ button. After the eighth preset, the first preset starts again and the equalizer is turned off.

Through the Software:

Double-click on the X-Rest 7.1 icon on the taskbar to launch the software. Then click on the “EQ” field to turn off the equalizer. The sound settings are now neutral.

To reset the equalizer setting, click on “EQ” and then click “Reset” on the top right.

The volume is too low

If the volume is too low, please check the overall volume of your operating system and set it to maximum volume.

The microphone is too quiet

Double-click on the X-Rest 7.1 icon on the taskbar to launch the software. Click on “Mic” and then, using your mouse, maneuver the slider until the desired microphone volume is reached. The boost function can also be activated.

Legal Disclaimer:

For potential loss of data, especially due to inappropriate handling, SHARKOON assumes no liability. All named products and descriptions are trademarks and/or registered trademarks of the respective manufacturers and are accepted as protected. As a continuing policy of product improvement at SHARKOON, the design and specifications are subject to change without prior notice. National product specifications may vary. The legal rights of the enclosed software belong to the respective owner. Please observe the license terms of the manufacturer before using the software. All rights reserved especially (also in extracts) for translation, reprinting, reproduction by copying or other technical means. Infringements will lead to compensation. All rights reserved especially in case of assignation of patent or utility patent. Means of delivery and technical modifications reserved.

Disposal of your old product:

Your product is designed and manufactured with high quality materials and components, which can be recycled and reused.



When this crossed-out wheeled bin symbol is attached to a product, it means the product is covered by the European Directive 2012/19/EU gild. Please be informed about the local separate collection system for electrical and electronic products. Please act according to your local rules and do not dispose of your old products with your normal household waste. The correct disposal of your old product will help prevent potential negative consequences to the environment and human health.

SHARKOON Technologies GmbH

Siemensstraße 38
35440 Linden
Germany

© SHARKOON Technologies 2016

info@sharkoon.com
www.sharkoon.com